











































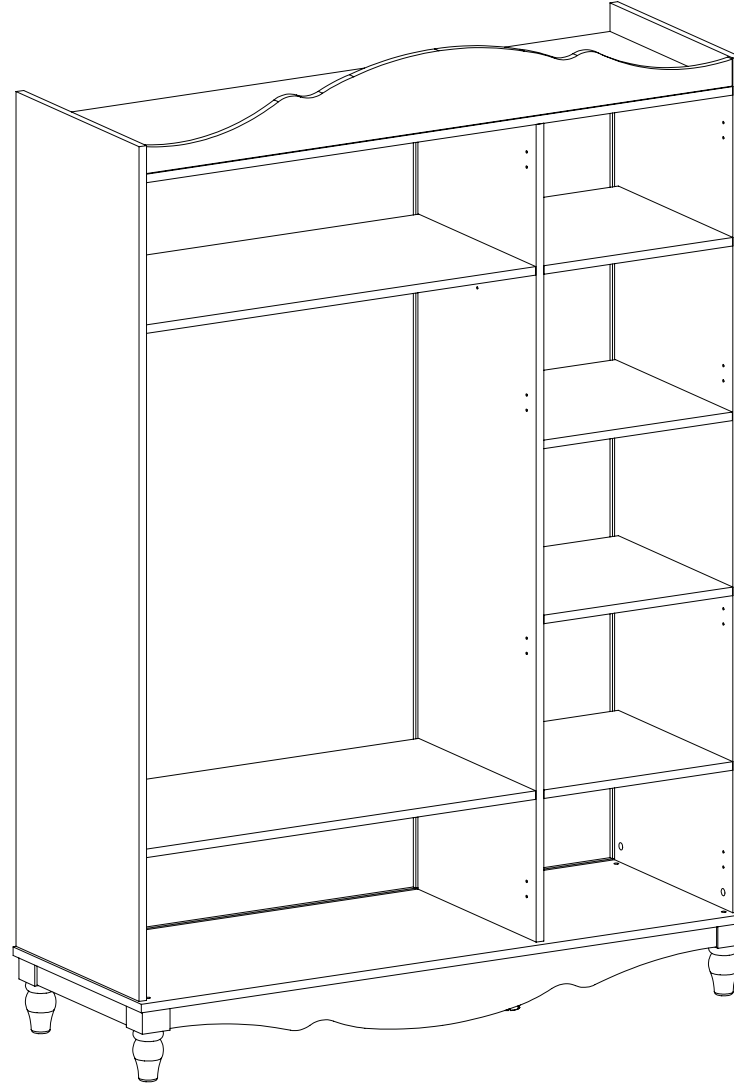
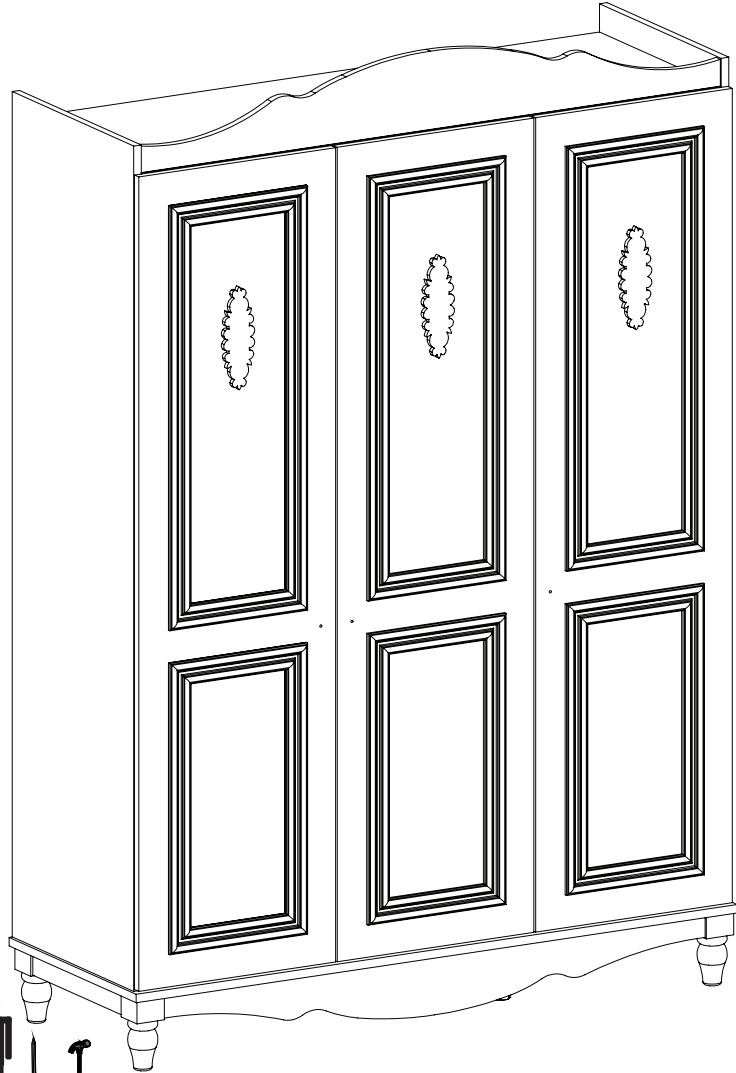

MALZEMELER
FITTINGS

KOD / CODE

																						
3.5 x 16 A1 x 92	M10 x 40 x 4	4 mm A5 x 1	M6 x 44 A6 x 32	M4 x 22 A11 x 6	15 x 11 B2 x 32	6 mm x 1	ø8 x 30 C2 x 36															
								x16	x12	x1	x3	x32	x2	x2	x8	x4	x1	x2	x1	x2	x1	x6



				
M4 x 25 A11 x 3	6 x 50 A3 x 3	3.5 x 20 x 8	x 6	x 4

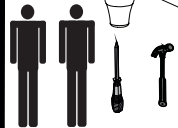

- Yedek malzeme isteklerinizi şemadaki kod ile belirtiniz.
- İLERİDE BAŞVURMAK İÇİN SAKLAYINIZ.



1

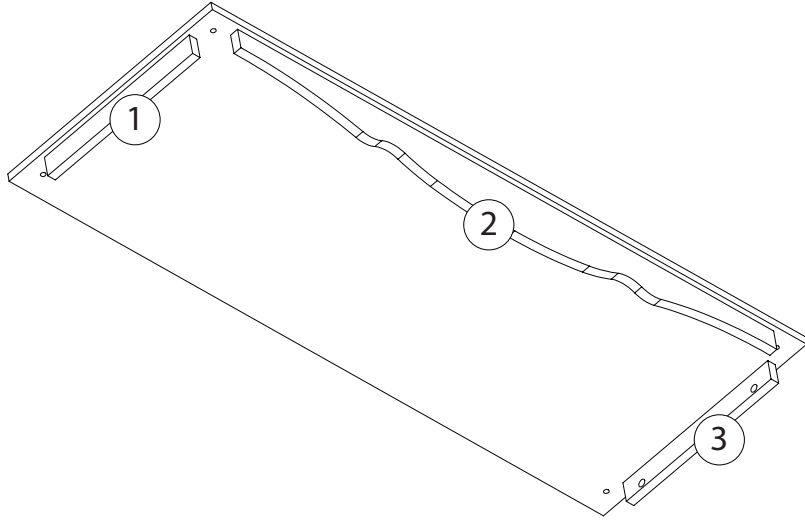

2

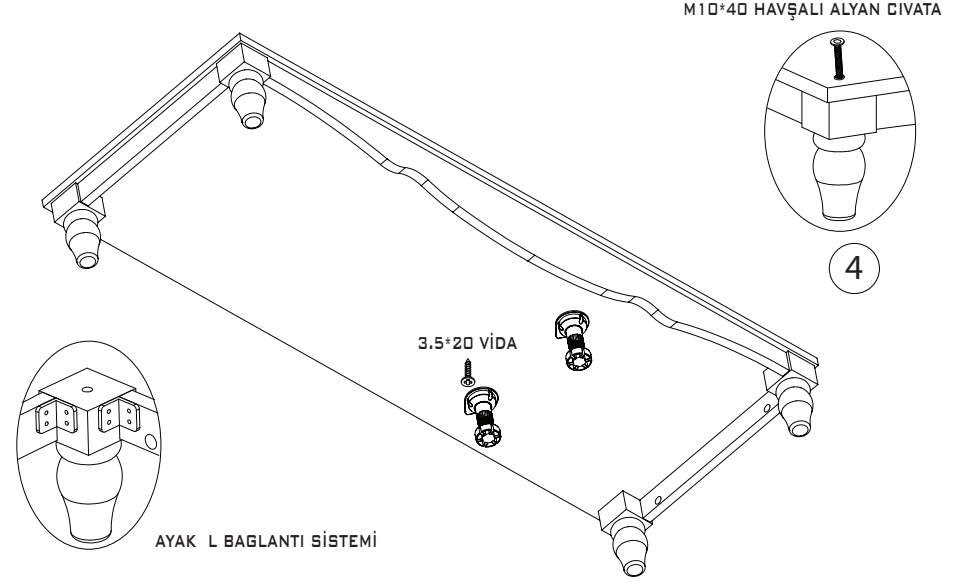

3

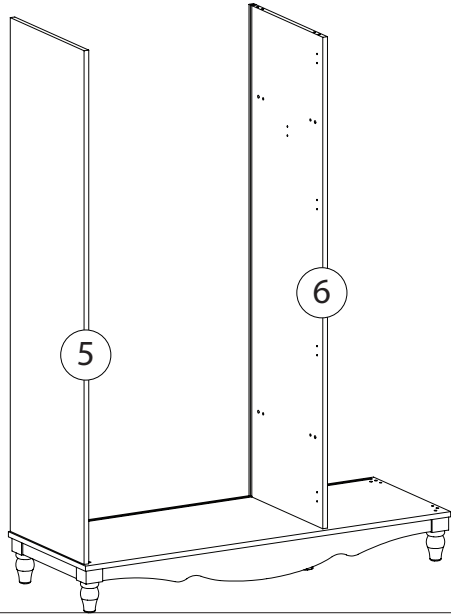

4

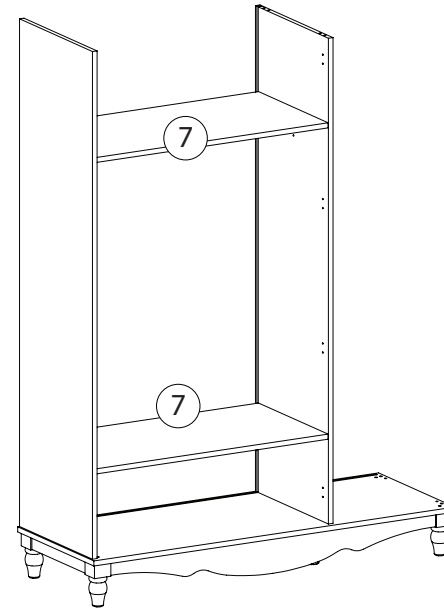

- Yedek malzeme isteklerinizi Őemadaki kod ile belirtiniz.
- İLERİDE BAŐVURMAK İŐİN SAKLAYINIZ.

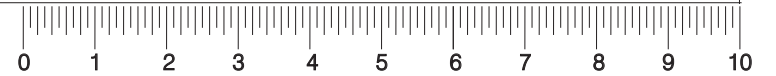

5

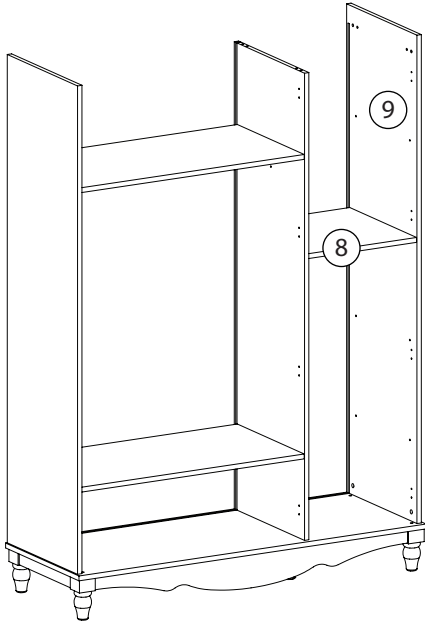

6

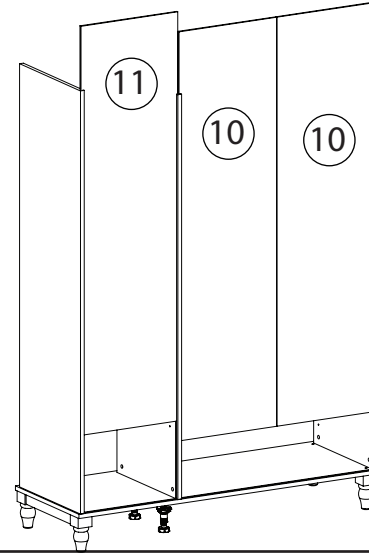

7

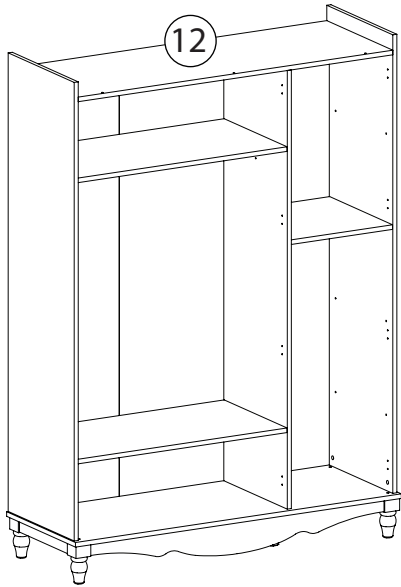

8

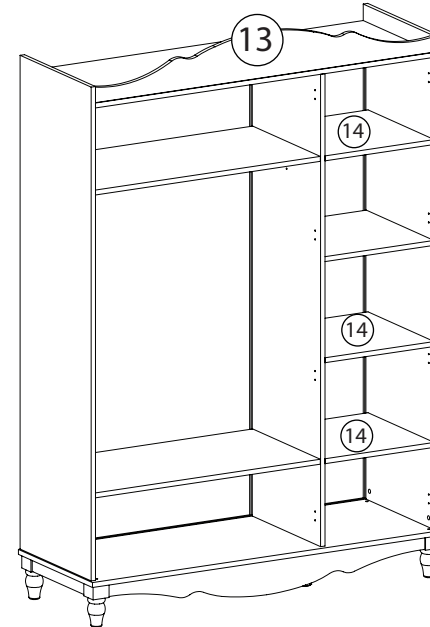

- Yedek malzeme isteklerinizi Őemadaki kod ile belirtiniz.
- İLERİDE BAŐVURMAK İŐİN SAKLAYINIZ.



9

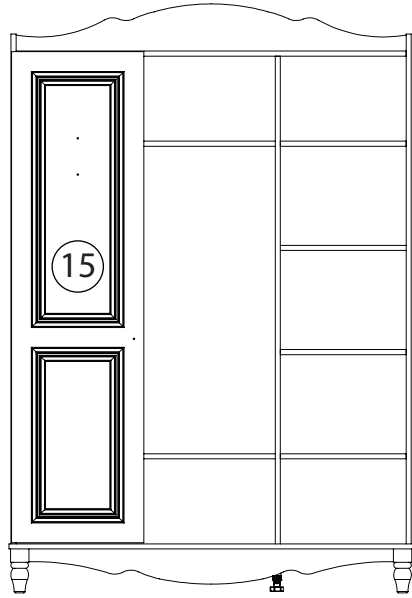

10

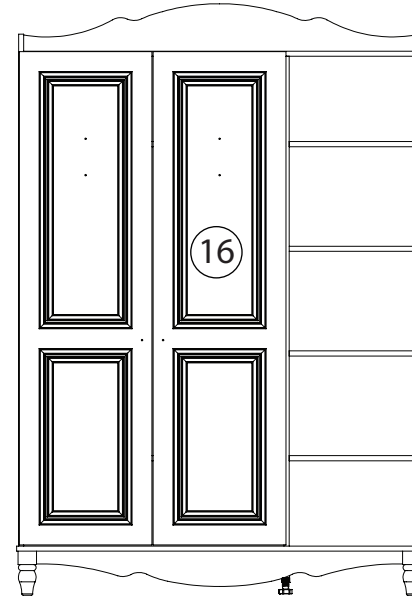

11

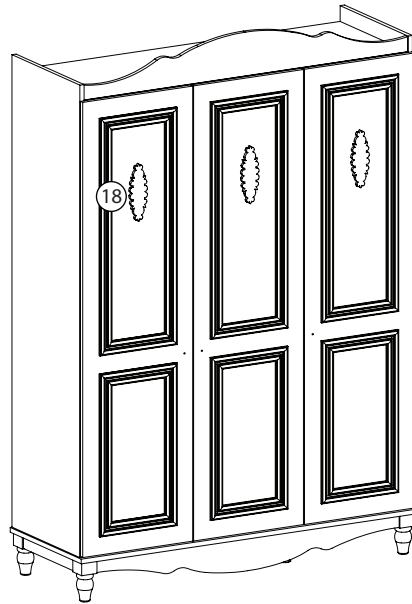
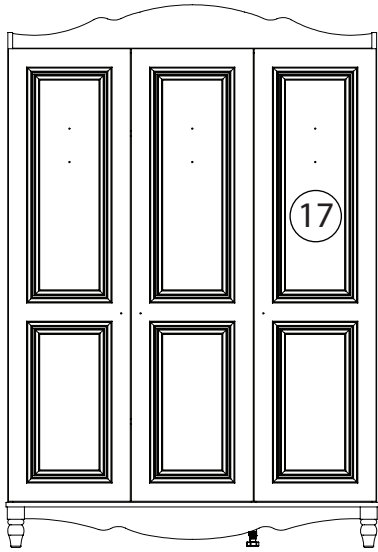

12

DİKKAT !!!!!

ÜRÜN MONTAJI YAPILIRKEN !!!!!

* ÜRÜNÜN SABİT KALACAGI YERE YAKIN BİR YERDE KURULMALIDIR

* ÜRÜN KURULU DURUMDA GEREĞİNDEN FAZLA İTME VE SÜRÜKLEYEREK
TAŐIMA YAPMAYINIZ

- Yedek malzeme isteklerinizi Őemadaki kod ile belirtiniz.
- İLERİDE BAŐVURMAK İÇİN SAKLAYINIZ.



