



























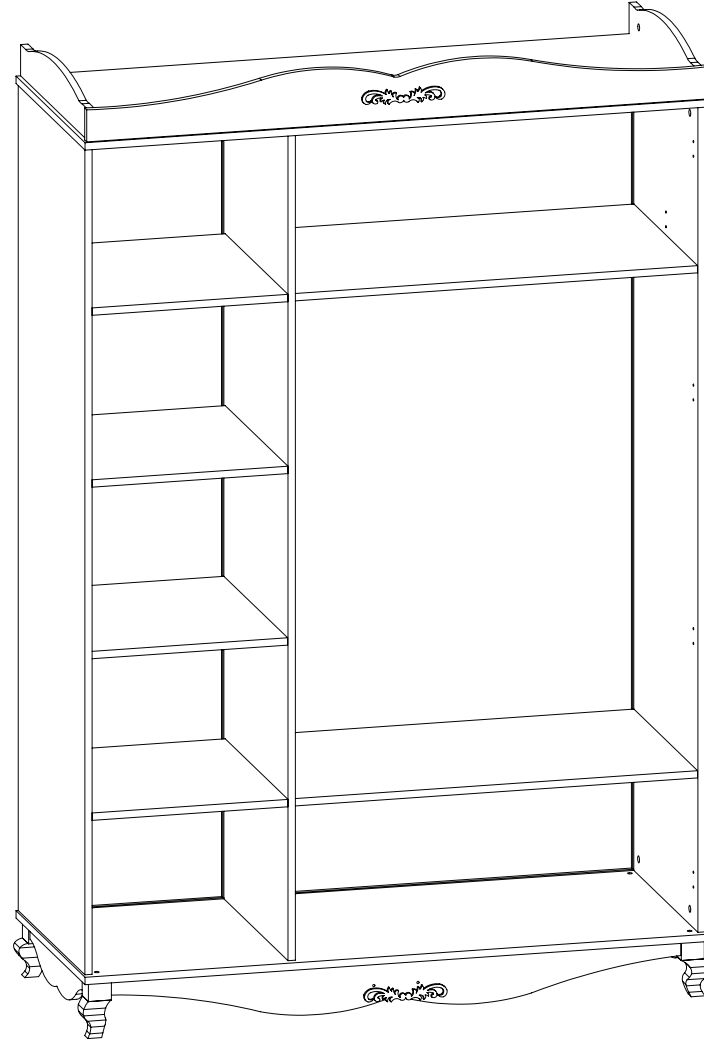
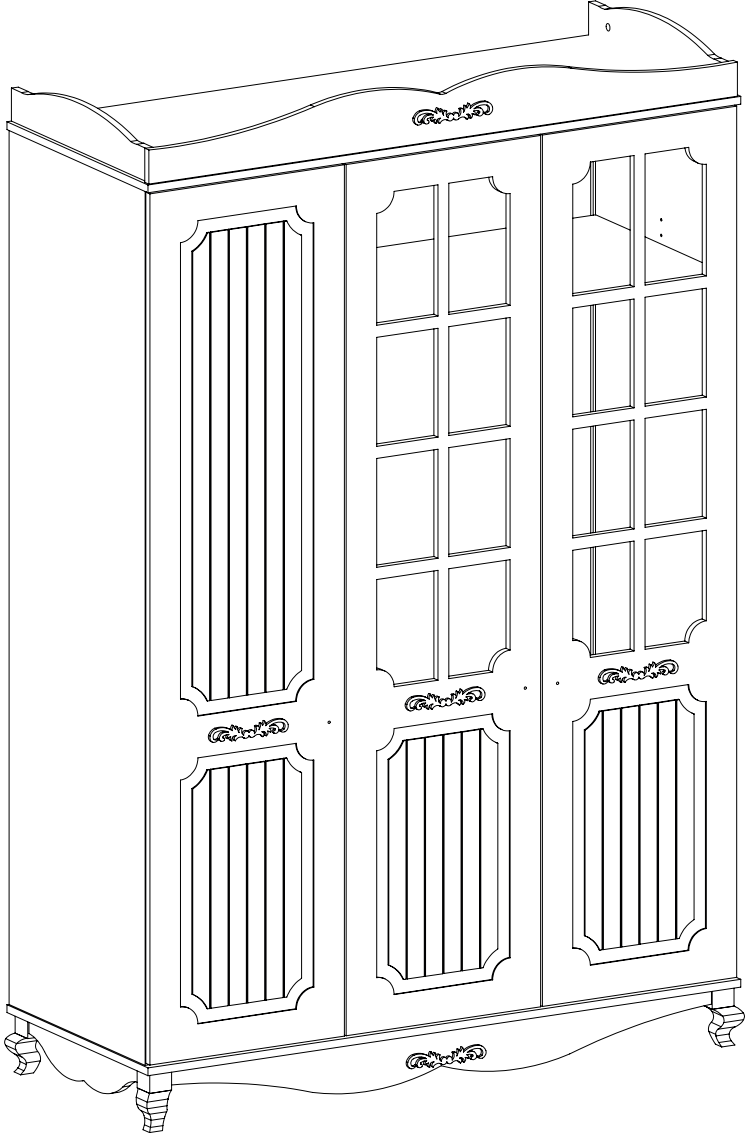

MALZEMELER
FITTINGS

KOD / CODE

																							
3.5 x 16	M10 x 40	4 mm	M6 x 44	M6 x 22	15 x 11	6 mm	ø8 x 30																
A1 x 140	x 4	A5 x 1	A6 x 40	A11 x 3	B2 x 40	x 1	C2 x 36	C3 x 18	C4 x 12	C6 x 1	C7 x 20	C8 x 40	C9 x 2	E3 3TK	E5 x 8	E9 x 4	E12 x 1	E34 x 2	E35 x 1	E37 x 12	G1 x 6		



				
x24	x 2	x6	x 5	x 4

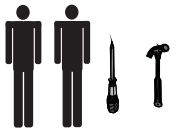

Ar-Ge

- Yedek malzeme isteklerinizi şemadaki kod ile belirtiniz.
- İLERİDE BAŞVURMAK İÇİN SAKLAYINIZ.

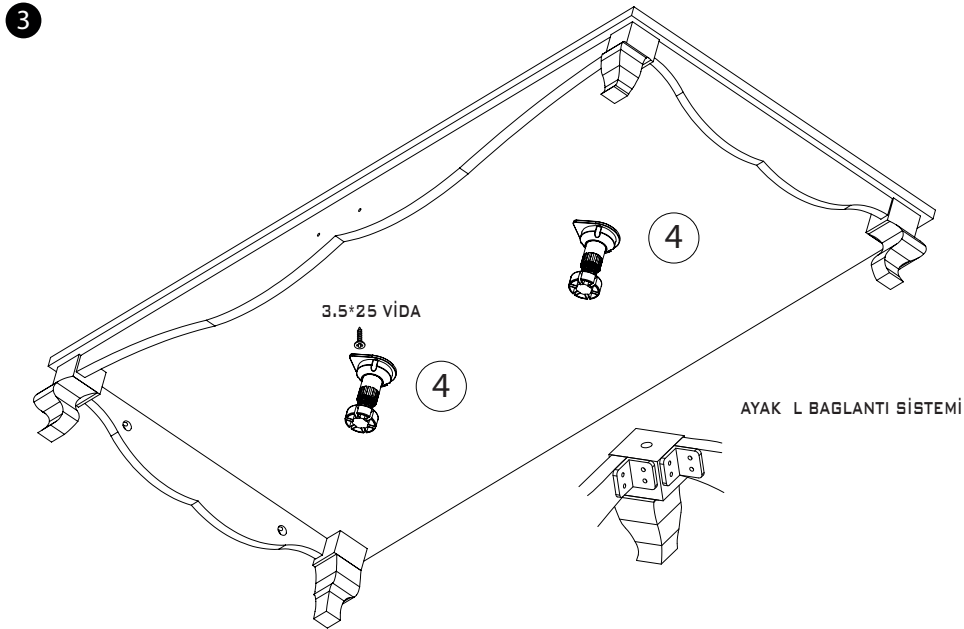
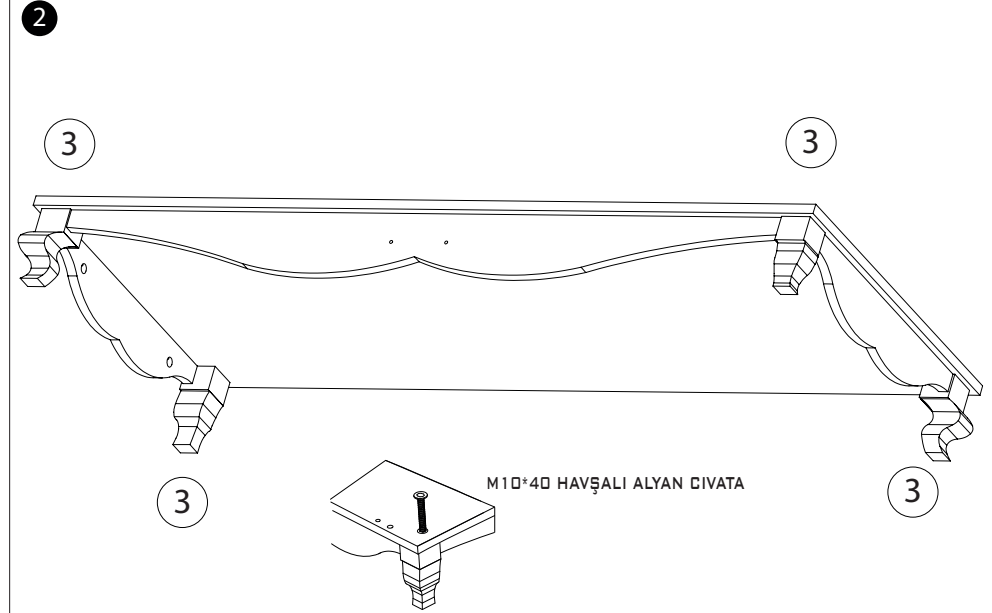
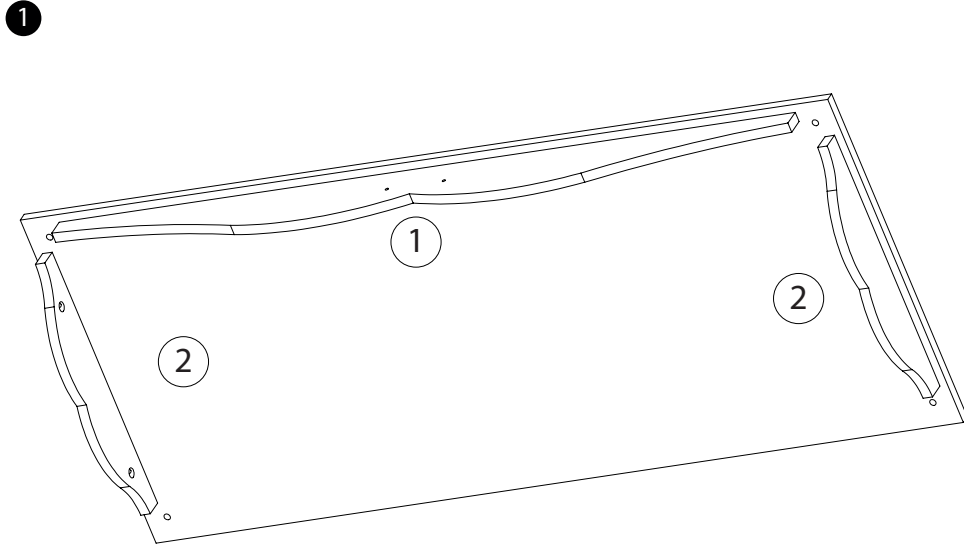

- Yedek malzeme isteklerinizi Őemadaki kod ile belirtiniz.
- İLERİDE BAŐVURMAK İŐİN SAKLAYINIZ.

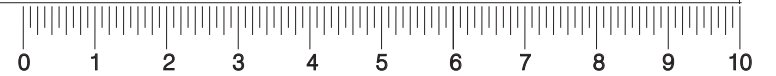

5

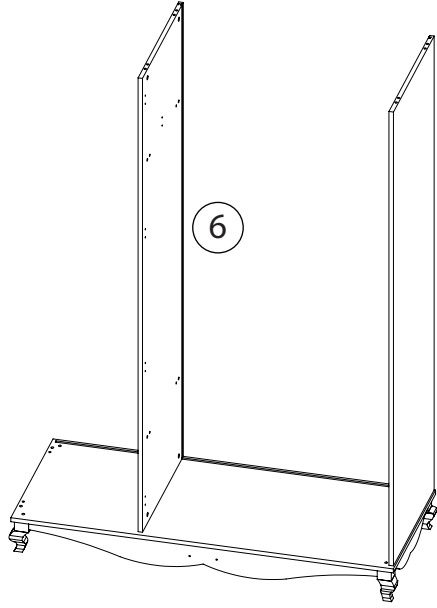

6

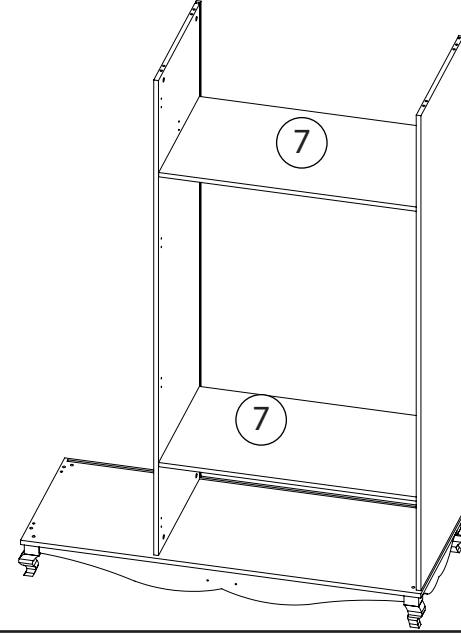

7

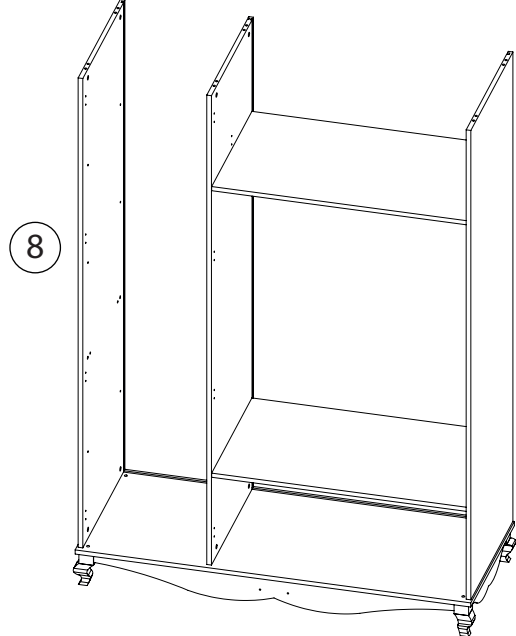

8

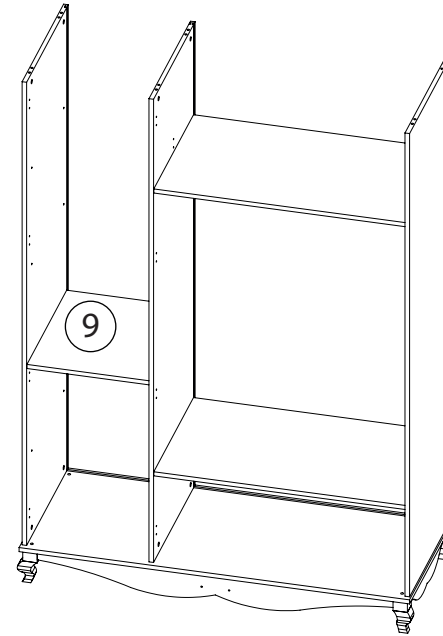

- Yedek malzeme isteklerinizi Őemadaki kod ile belirtiniz.
- İLERİDE BAŐVURMAK İÇİN SAKLAYINIZ.



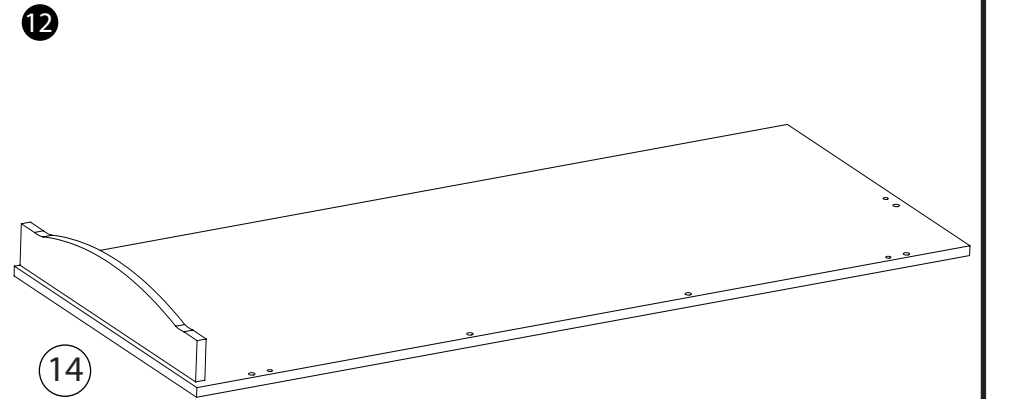
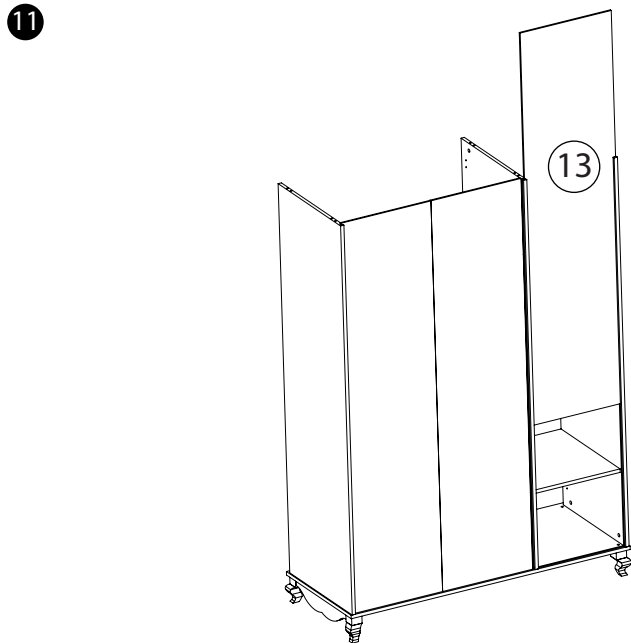
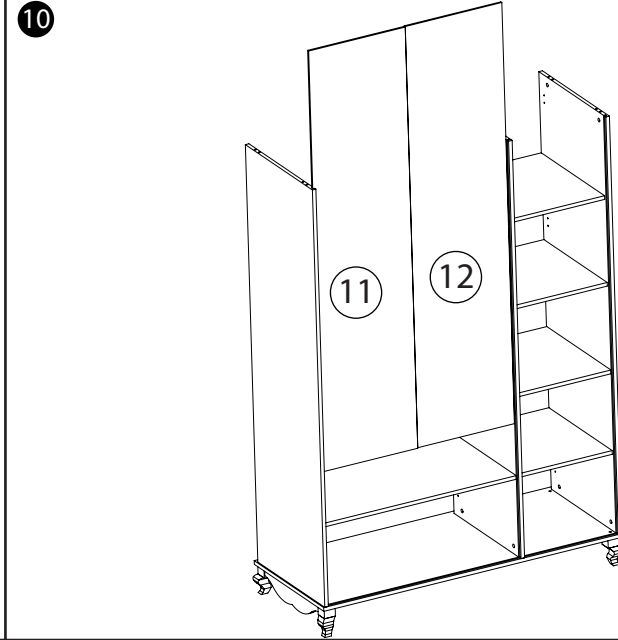
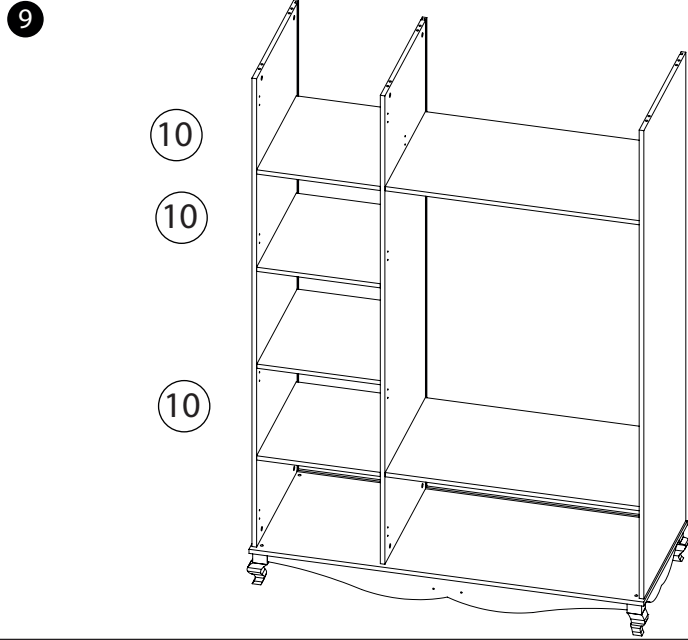

- Yedek malzeme isteklerinizi Őemadaki kod ile belirtiniz.
- İLERİDE BAŐVURMAK İÇİN SAKLAYINIZ.



13

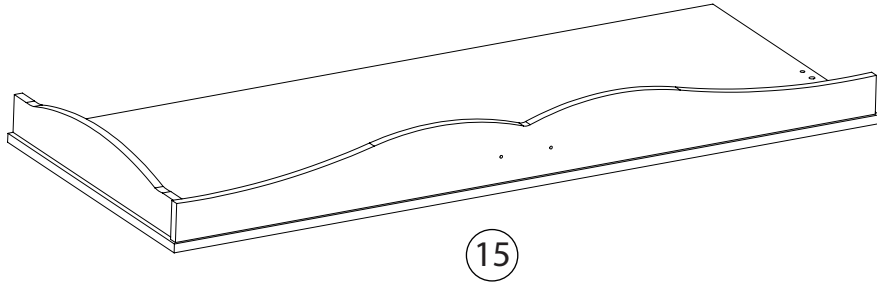

15

14

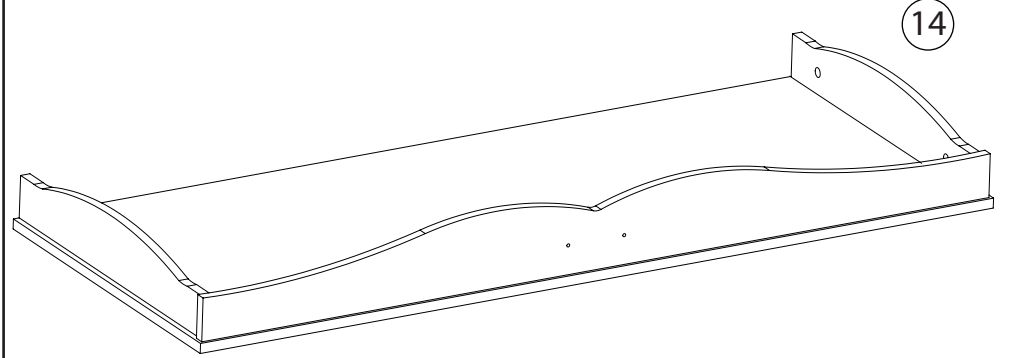

14

15

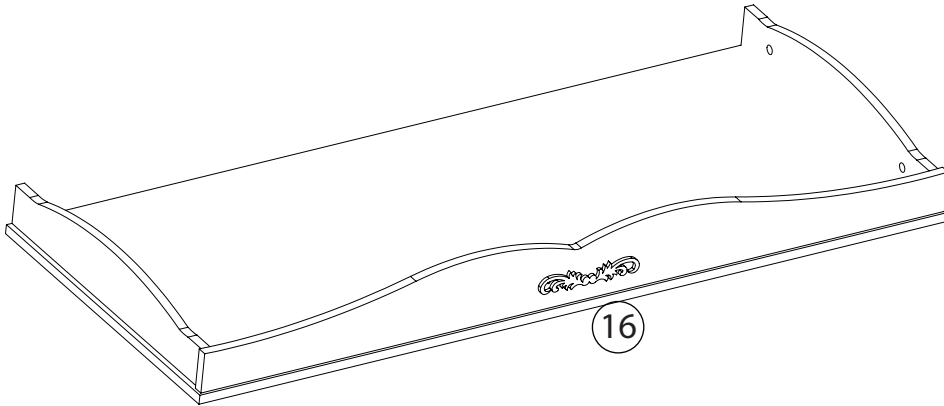

16

16

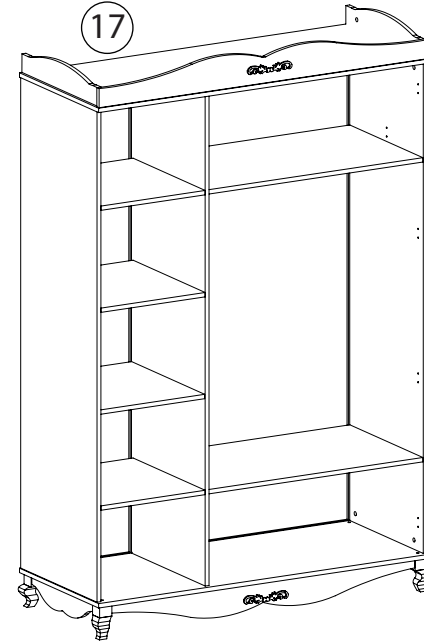

17

- Yedek malzeme isteklerinizi Őemadaki kod ile belirtiniz.
- İLERİDE BAŐVURMAK İÇİN SAKLAYINIZ.



17

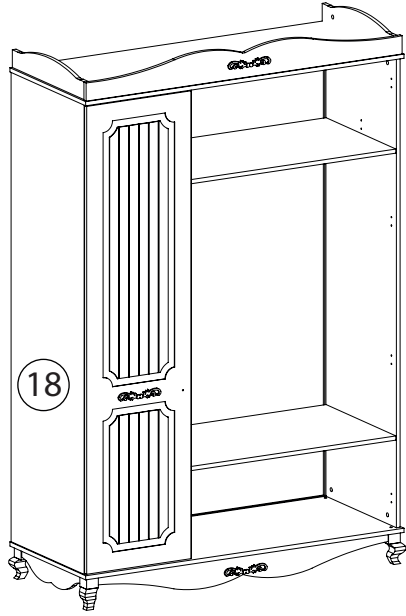

18

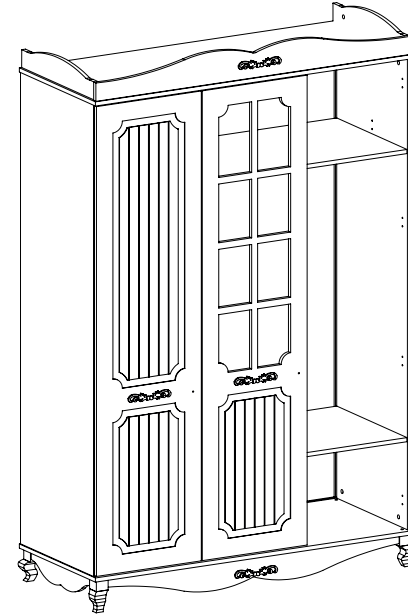

19

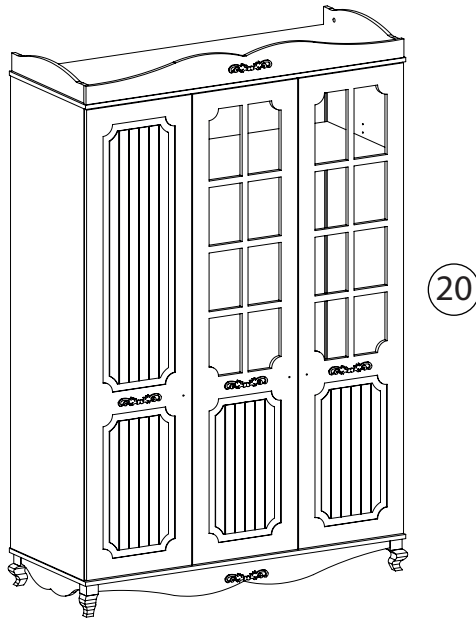

20

KAPAK PLEKSİ BAĞLANTI SİSTEMİ

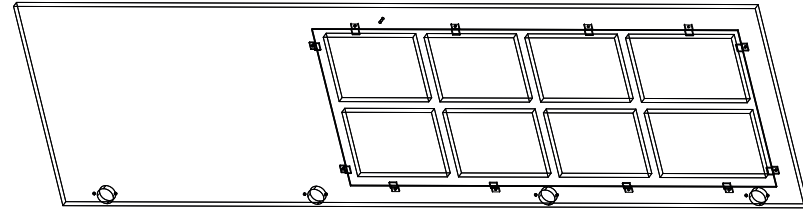

DİKKAT IIII

ÜRÜN MONTAJI YAPILIRKEN

ÜRÜNÜN SABİT KALACAGI YERE YAKIN BİR YERDE KURULMALIDIR

ÜRÜN KURULU DURUMDA BEREĞİNDEN FAZLA İTME VE SÜRÜKLEYEREK

TAŐIMA YAPMAYINIZ

- Yedek malzeme isteklerinizi Őemadaki kod ile belirtiniz.
- İLERİDE BAŐVURMAK İÇİN SAKLAYINIZ.

